



Download APP



YouTube

# ATL-230 Quick Installation Guide

## First Installation

Install mSD Card, keep contact pins side up, and insert with arrow angle

\*Format mSD card before use.

\*Seal battery cover firmly to avoid from moisture damage, or will be considered as a human cause factor which not covered by warranty.

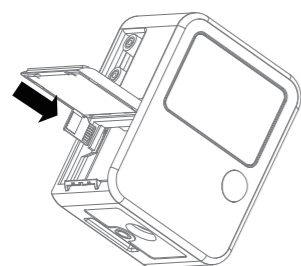

Install Camera Battery(AA\*4pcs) .

\*Lithium battery or any battery voltage higher than 1.7 volts are not recommended.

\*Diameter larger than 14mm are not recommended.

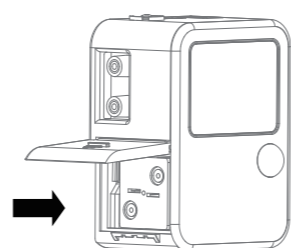

Push the power button until you hear the beep

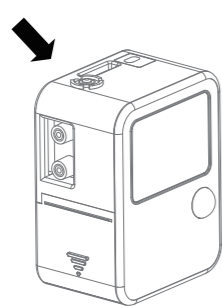

Insert desiccant sheets into the bottom gap  
Renew desiccant sheet before recording

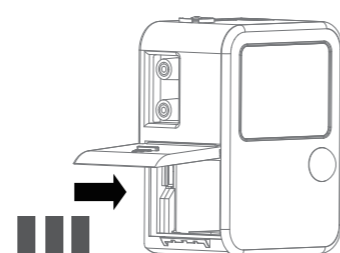

## Camera Parts

Shutter & Power Button

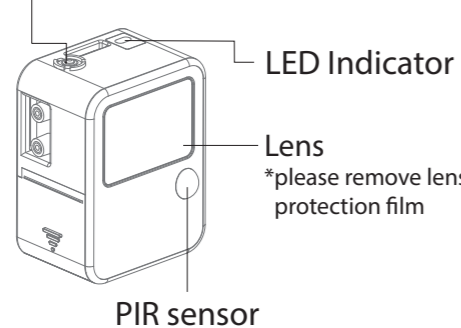

Micro USB Socket Strap Eyelet  
\*Power input: DC5V 1A

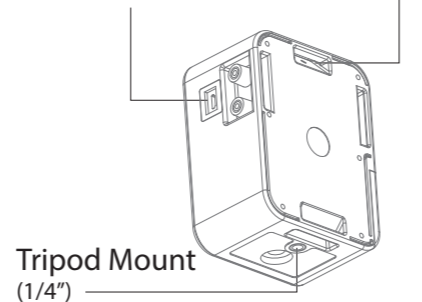

2

## Connecting

On your phone setting

Step 1: Turn on your mobile phone WI-FI. In WI-FI SSID select the time lapse camera

ATL230\_XXXXXXXXXX. Default password is 12345678

Step 2. Open Afidus TLC APP. Click "Access control page"

icon to connect with the ATL-230.

Step 3: Set up camera parameter and enjoy time lapse after click "Record"

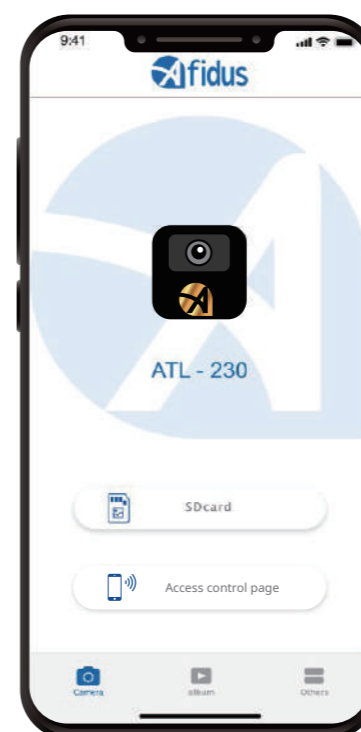

Step 2



Step 3

## Main Screen:

Camera  
Connect your smartphone with Afidus camera

album  
Downloaded time lapse video/snapshot

Others  
Firmware info and FAQ

3

## Camera Icons:

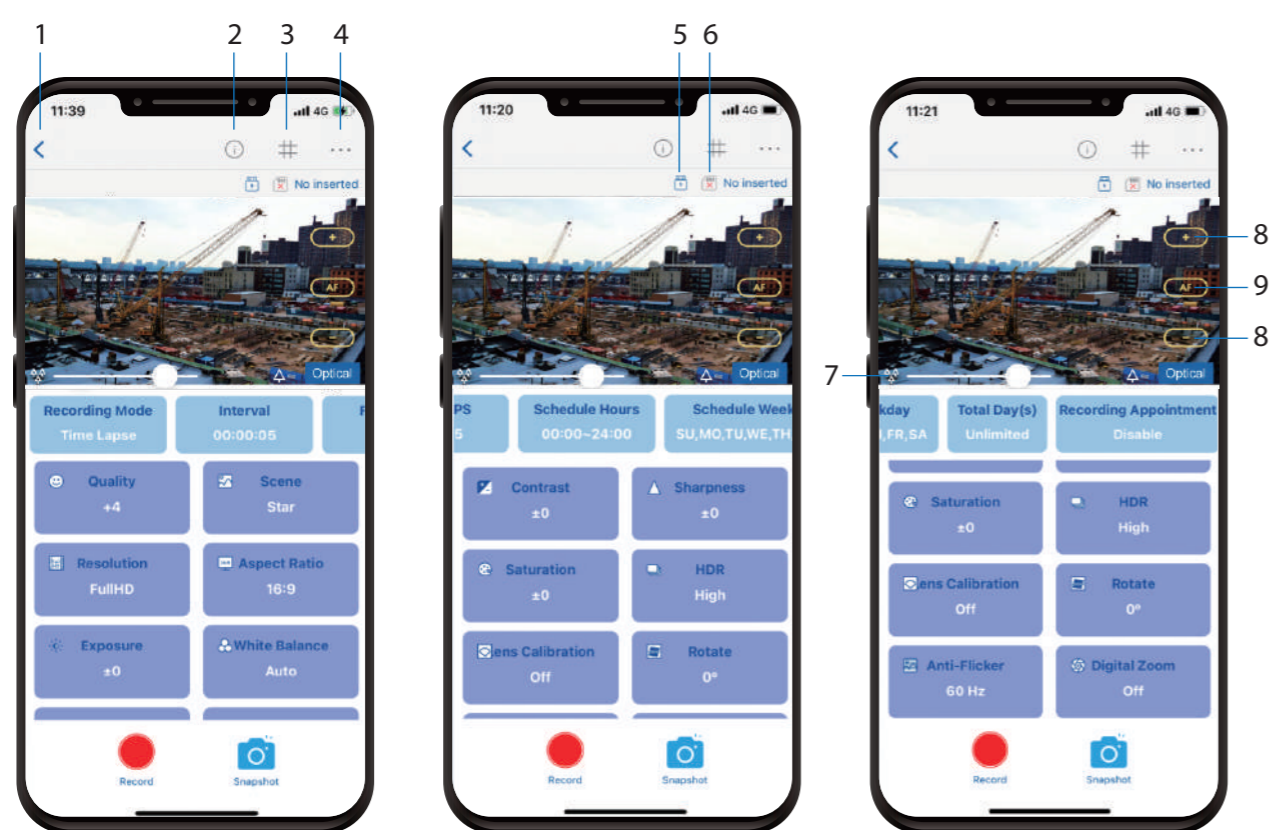

1. Home : Back to main page

2. Current parameter : Show current parameters

3. Grid : 3x3 grid

4. More Settings : Enter more settings page

5. Power supply : Current power supply

6. Memory card : Current memory card status

7. Zoom : Drag to adjust zoom in/out

8. Focus: Tap to adjust focus

9. Auto focus : Tap to auto focus

## To Start/Stop recording with APP

### To Start Recording:

1. Press power button on time lapse camera until you hear a beep and LED green color
2. On smart phone apps, select "access control page" and "record"
3. APP shows current setting, tap "record"
4. Enjoy it instantly

4

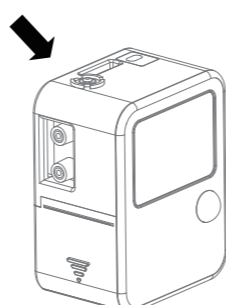

## To Stop Recording:

Press power button on time lapse camera for 2 seconds After LED indicator flashes and you hear a beep, recording will stop automatically and time lapse video will be generated immediately

## Replay & Download Time Lapse Video from Camera to APP:

1. Open Afidus APP.
2. Tap "SD card" icon.
3. Tap download icon.
4. Video will download to APP.

## Download Time Lapse Video from APP to SmartPhone:

1. Tap "Album" icon at homepage.
2. Long press and select file document (Stop Motion, Timelapse, Snapshot)
3. Tap "share" icon and select download.

## Share Time Lapse Video:

Tap "share" icon to share videos on social media or to someone through communication APP.

## LED Indicator:

Power on: Green  
No SD card: Red  
Battery Low: Red Flash/6 sec.  
Recording: Green/6 sec.  
Stop Motion, Timelapse, flash 0.2s

## Camera Reset to Default:

1. Press reset button (hold), and plug in USB power input (external power input).
2. Release power button after hearing (short beep\*2 long beep\*1).

5